



SOLAR LED STREET LIGHT

Ultra Lumens-All-in-Two Designs 2018

Key Advantages

PROGRAMMABLE

Smart solar controller built-in, power brightness and lighting time are adjustable via remote controller.

MICROWAVE SENSOR

More area can be covered than PIR sensor, longer distance and wider sensitive angle, more stable than PIR.

EXTERNAL SOLAR PANEL

Solar panel separated from light allows to increase power to meet the solar radiations in different latitude and longitude. Max 200W solar panel is allowed for 50W LED with 6200lm output.

CONNECTION

MC4 male & female plugs directly to 18V solar panel. quick and easy for connection. 2.5mm² power cord for less voltage drop.

COMPACT SYSTEM

Battery and solar controller, sensor are built-inside of light, only need to be connected to 18V system, NO more other operation, easy, simple and quick installation.



MC4 Connector



Microwave sensor



Lithium Battery



Philips SMD LED



Remote
Setting



Microwave
Sensor



MC4 Plugs
Connection



Lithium
Battery



12 Hrs/Day
130 LM/W

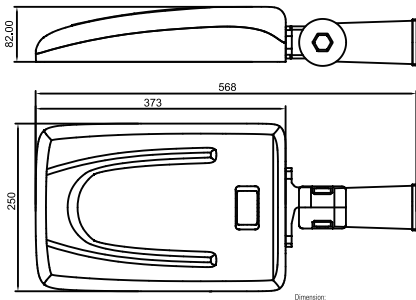

IES Data

Light Distribution Curve [Unit:cd]

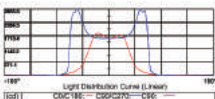
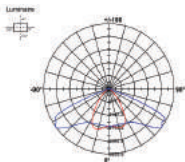

Max Plane Light Distribution Curve [Unit:cd]

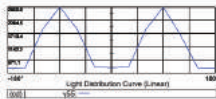
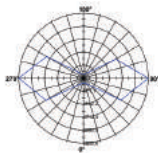

Induction Sensor

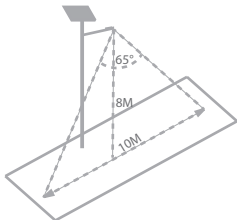

Microwave (Radar) sensor is adopted in this light in order to save more energy. Energy saving mode is adjustable by the remote control easily. Radar sensor is more sensitive than PIR sensor in much wider angle and longer distance, And it can be triggered easily with slight movements. The best sensitive distance from people / object to light sensor should be within 12 meters.

PIR sensor is optional

Product Ranges

Model	AI-U15W	AI-U20W	AI-U30W	AI-U40W	AI-U50W	AI-U60W
Power.max	15W	20W	30W	40W	50W	60W
Luminous flx	>1,800lm	>2,400lm	>3,600lm	>5,000lm	>6,000lm	>7,000lm
Beam angle	140°70 Degrees					
Color Temp.	2700K-6500K Optional					
CRI	>83					
LED Brand	Philips SMD3030					
LED Qty	48Pcs		72Pcs		90Pcs	
IP Rating	IP67					
Battery	195WH	268WH	391WH	488WH	548WH	635WH
Controller	PWM type with sensor		MPPT type with sensor			
Solar Panel						
P.max(W)	40W	50W	70W	90W	100W	110W
V.mp. of PV	18V					
I.mp. of PV	2.22A	2.78A	3.89A	5.0A	5.56A	6.12A
PV Size(mm)	670*420*25	700*535*30	670*590*25	760*670*30	1040*670*30	1040*670*30
Pole Height	3~4M	3~5M	3~6M	4~6M	5~8M	6~12M



Bug Free



No Mercury



Bright Color



Long Lifetime



Low Wattage



Energy Saving



Eco Friendly

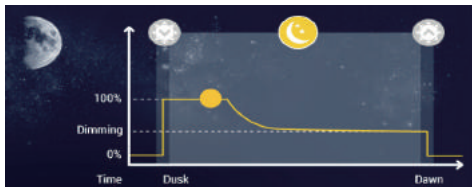

Example A of Program Setting: (With sensor Function)

Time-1: 3 hours 100% bright. (The light will work with 100% bright at this 3 hours times)

Time-2: 4 hours 50% bright. (Dimming)

(In this period, the light will become 80% bright when people close the light about 30 seconds, and 50% bright when people leave the light.)

Time-3: 5 hours 30% bright. (Dimming)

(In this period, the light will become 50% bright when people close the light about 30 seconds, and 30% bright when people leave the light.)

Example B of Program Setting: (Without sensor Function)

Time-1: 3 hours 100% bright. (The light will work with 100% bright at this 3 hours times)

Time-2: 4 hours 50% bright. (The light will work with 50% bright at this 4 hours times)

Time-3: 5 hours 30% bright. (The light will work with 30% bright at this 5 hours times)

Tips:

- 1: Length of each time block is adjustable from 0~15 hours freely.
- 2: Brightness of each time block is adjustable from 0% to 100% freely.
- 3: The time delay when sensor is activated is adjustable from 10 seconds to 150 seconds.
- 4: The working hours and brightness should be based on the battery capacity.



Solar Street Light with microwave sensor



Solar Street Light without sensor



Lithium Battery Pack

High temperature resistant, up to 2000 cycles lifetime. (DOD 70%)
Smart BMS protection.



PHILIPS

Philips SMD LED Source

More LEDs is used, driven with lower current, achieving more than 150lm/w.
High efficiency than normal solar lights.



MPPT Solar Controller

Higher charging efficiency than PWM controllers, Ensuring enough power generated for every night,



Aluminium material, anti-UV & Oxidation
High performance.



Adjustable brackets

Marked with digitals, easy to adjust up/down when installation. Flexible for different projects condition



Microwave & PIR sensor

Two kinds of sensors are optional for different applications for different sensitive performance.







Ledcon - Smart LED Lighting
Website: www.ledcon.be
Email: info@ledcon.be
Tel: +32 89 39 59 22